

File Recessed

code F1004.840P/01



PRODUCT DESCRIPTION

Direct light indoor recessed lamp made of extruded aluminum 6060; complete with led; color rendering index CRI >90. Professional led 38.4 W modules assembled and wired on extruded aluminum heatsink with high performance reflector, equipped with harmonic steel springs for installation in the profile Tools free; wiring through 5 cables with quick coupling terminal blocks; protocol On/Off. Lamp with color finish white; in polycarbonate with diffusing film. Degree of protection IP40/IP43.

PRODUCT SPECS

Installation method	Recessed with frame
Light source	LED
Absorbed power	38,4 W
Color temperature	4000K
Color rendering index CRI	>90
Optic	Opal polycarbonate diffuser
Finishing	White
Luminous flux of the product	2228 lm
Luminous efficiency	58 lm/W
MacAdam color tolerance	3
Life time estimate	50000h Ta 25° L80B10
Protocol	On/Off
Energy efficiency class	D
Weight	1.6 Kg
Dimension	L1700 mm
Hole size	42xL+2 mm
IP Grade	Inst. Parete Ip40 / Inst. Soffitto Ip43
Power supply	220-240V 50-60Hz

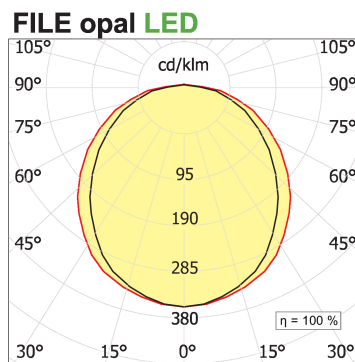
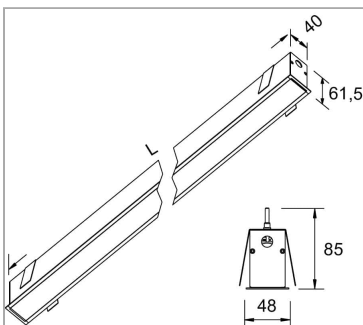

WEB PAGE



ASSEMBLY INSTRUCTIONS



