

Leva System Tilt module B5

code LV092K.927FD/01

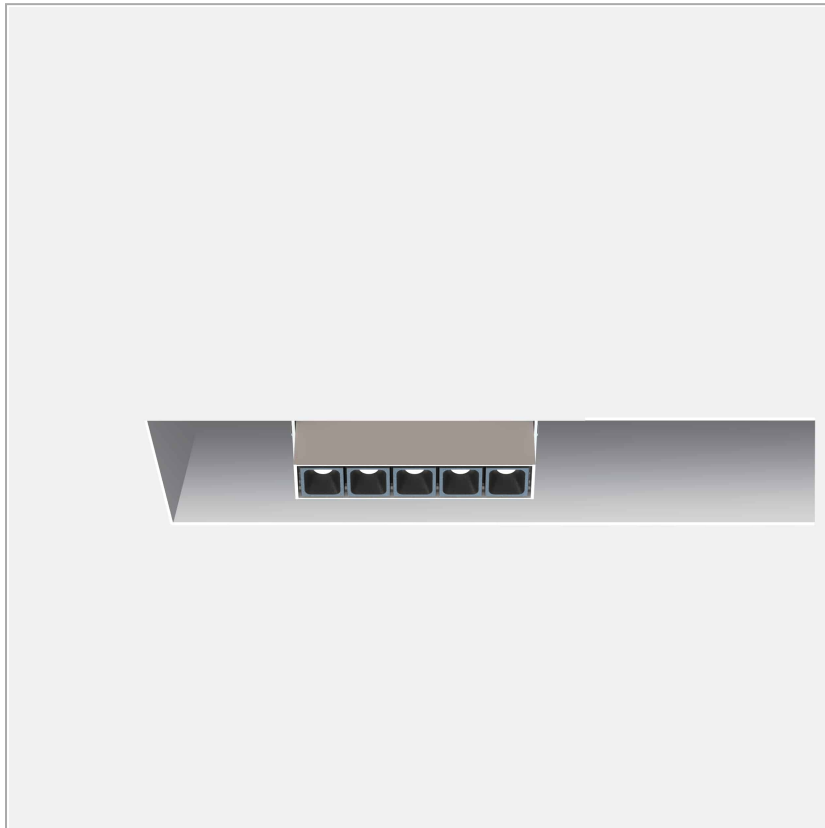

PRODUCT DESCRIPTION

Fix and adjustable projectors programme for chip on board LED sources. Mounting options: with frame and trimless recessed, ceiling and wall-mounted, 230V Eurostandard track and within the Lucifero's Container for Minifile and File 2. Fixture's body in painted extruded aluminum. Optical group complete with chip on board led, lens, antiglare housing and driver (except recessed versions and 1x and 3x ceiling/wall-mounted versions). Adjustable version for ceiling/wall mounting and for insertion within the Container for Minifile provided with special patented Soft Rotate & Slide mechanism, that allows the projector's extraction and aiming of 350° on the vertical axis and of 350° on the horizontal axis. Adjustable version for insertion within the Container for File 2 provided with special tilt mechanism, that allows the projector's extraction and aiming of +/-45° on the horizontal axis. Spot, flood and wide optics. UGR<19. Degree of protection IP23/43.

PRODUCT SPECS

Installation method	system
Light source	LED
Absorbed power	5x2,2 W
Color temperature	2700K
Color rendering index CRI	>90
Optic	Flood 32°
Finishing	White box - black optic
Luminous flux of the product	1075 lm
Luminous efficiency	98 lm/W
MacAdam color tolerance	2
Life time estimate	50000h Ta 25° L90B10
Protocol	Dimmable Dali
Energy efficiency class	E
Weight	1.67 Kg
Dimension	L160xW75xH110+38 mm
IP Grade	IP20
Power supply	220-240V 50-60Hz

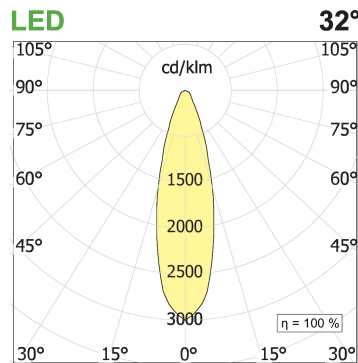
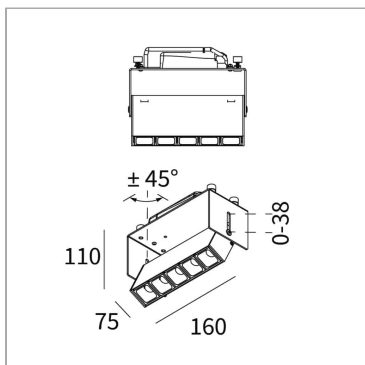

WEB PAGE



ASSEMBLY INSTRUCTIONS



MANDATORY ACCESSORY ACCORDING TO THE TYPE OF INSTALLATION

Box Leva 5 tilting



code LV005B/01

Trimless recessed uncategorized wallbox for brick wall / wallbox for false ceiling. Bianco finishing
wallbox for brick wall / wallbox for false ceiling

Technical Sheet

