

Iride recessed minimal adjustable

code IR26.935W/01



PRODUCT DESCRIPTION

New collection of adjustable projectors by Mario Cucinella featuring integrated LED sources, ceiling or track mounted (Stucchi tracks) both for mains voltage or 48V. Iride consists of a body in painted die-cast aluminum and an interchangeable ring – in white, black or chrome finishing – for customization. Optical groups complete with high color rendering LEDs (CRI>90), lens, anti-glare housing and electronic driver. Adjustable optical body in the track version, with the 0-90 ° orientation on the horizontal axis and 355 ° on the vertical axis; the surface mounted version offers an additional rotation possibility. Spot, flood and wide optics. IP20.

PRODUCT SPECS

Installation method	recessed
Light source	LED
Absorbed power	26 W
Color temperature	3500K
Color rendering index CRI	>90
Optic	Wide 36°
Finishing	White
Luminous flux of the product	2108 lm
Luminous efficiency	81 lm/W
Life time estimate	3SDCM 50000h L90 B10 Ta 25°C
Energy efficiency class	E
Dimension	Ø114 mm
IP Grade	IP20
Power supply/Transformer	Not included
Protocol	See power supply

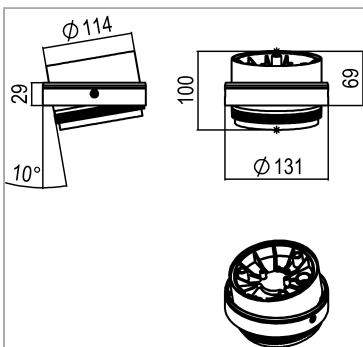

WEB PAGE



ASSEMBLY INSTRUCTIONS



OPTIONAL ACCESSORIES

Private:

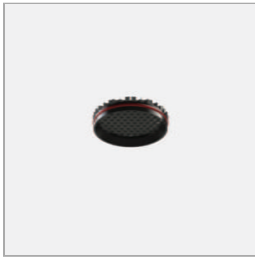

code L114R

Non-reflective accessory lens with a honeycomb structure, diameter 86 mm.

Technical Sheet



